









 Ø6,3x50 mm A1 x 34	 Ø12 mm A2 x 34	 4 mm A3 x 1	 Ø15x12 mm B1 x 12	 Ø5x44 mm B2 x 12
 Ø20 mm B3 x 12	 Ø4x16 mm D1 x 44	 Ø3x25 mm D2 x 6	 Ø1,6x25 mm F x 114	 Ø8x36 mm G x 31
 K x 3	 Ø5x16 mm L x 8	 M x 2	 N x 5	 Z x 6

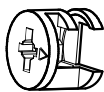
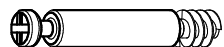

Box 1/2

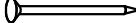
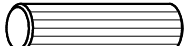
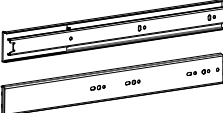
799x424x16 mm

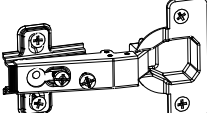
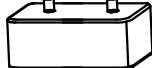

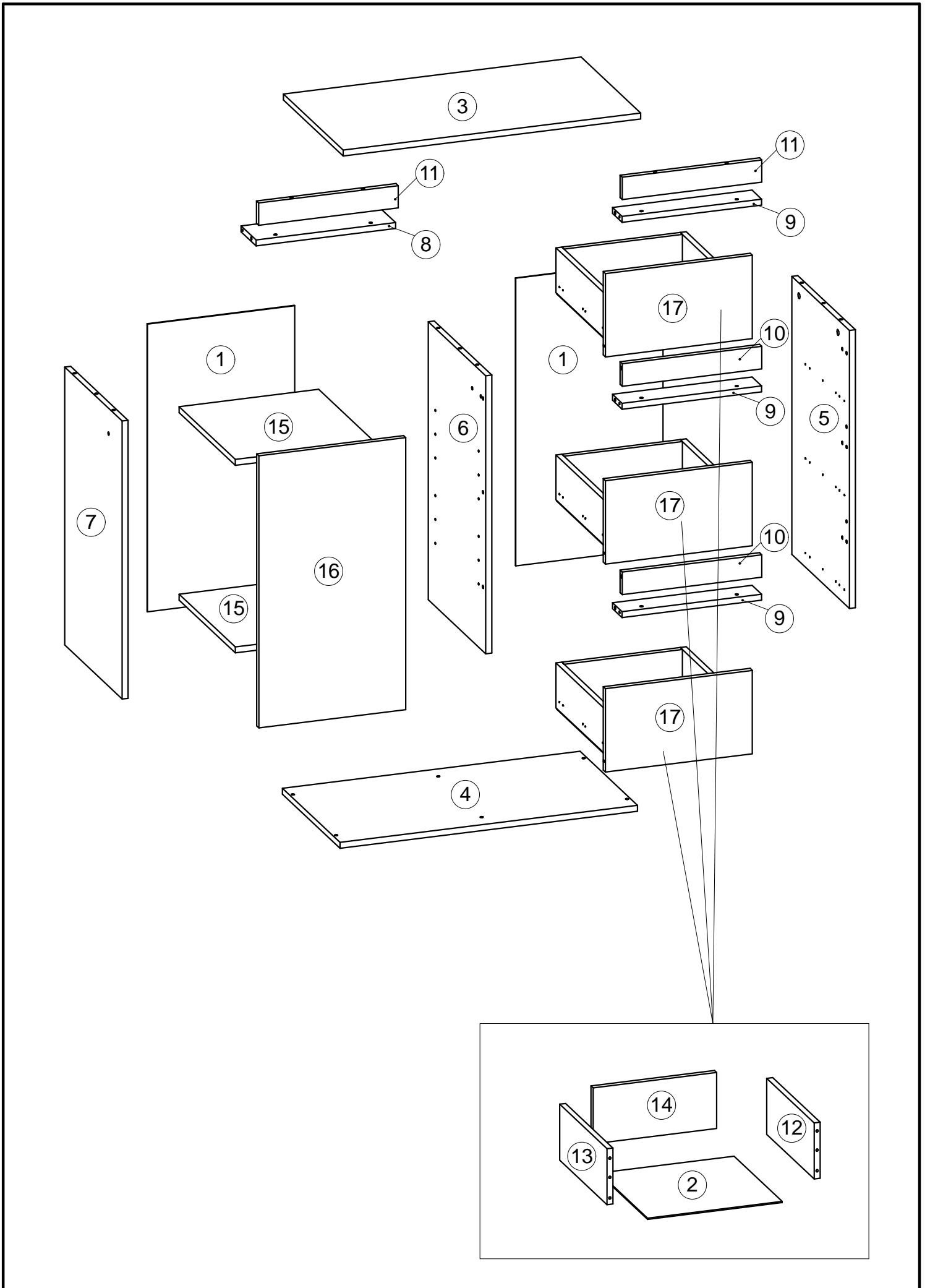
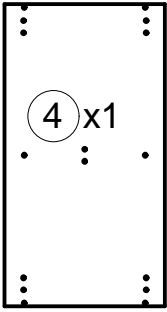
747x424x16 mm

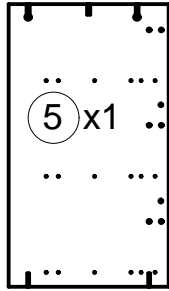

747x424x16 mm

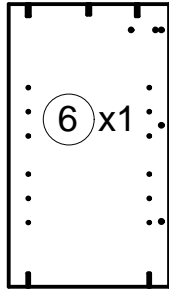

747x424x16 mm

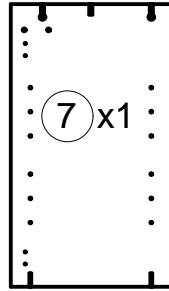

375x110x16 mm

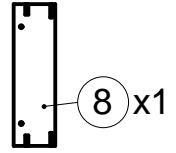

Fittings & Tools

375x70x16 mm

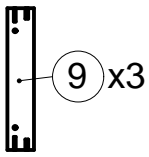

375x60x16 mm

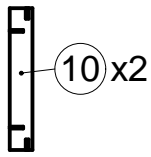

375x60x16 mm

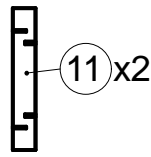

400x120x16 mm

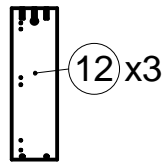

400x120x16 mm

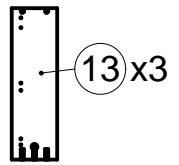

318x120x16 mm

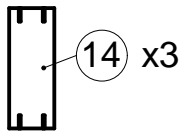

414x375x16 mm

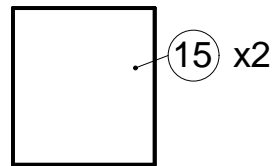

Box 2/2

773x396x3 mm

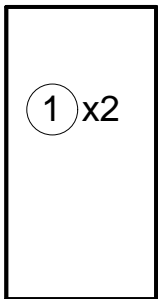

406x348x3 mm

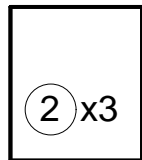

799x440x16 mm

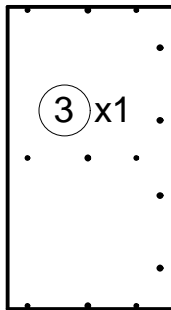

394x730x16 mm

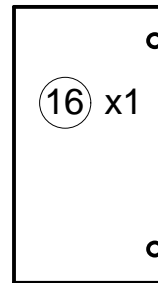

394x223x16 mm

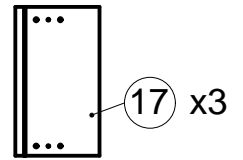

1



B1 x 2



G x 5

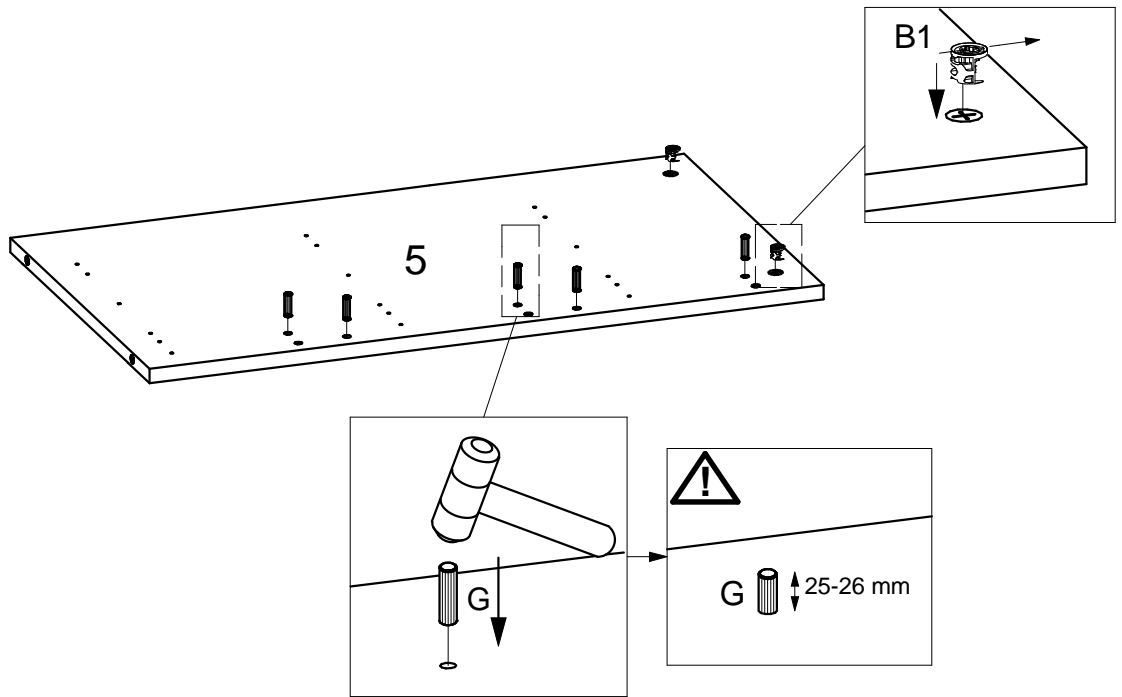
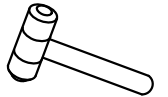
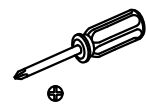

2



B1 x 2



G x 5

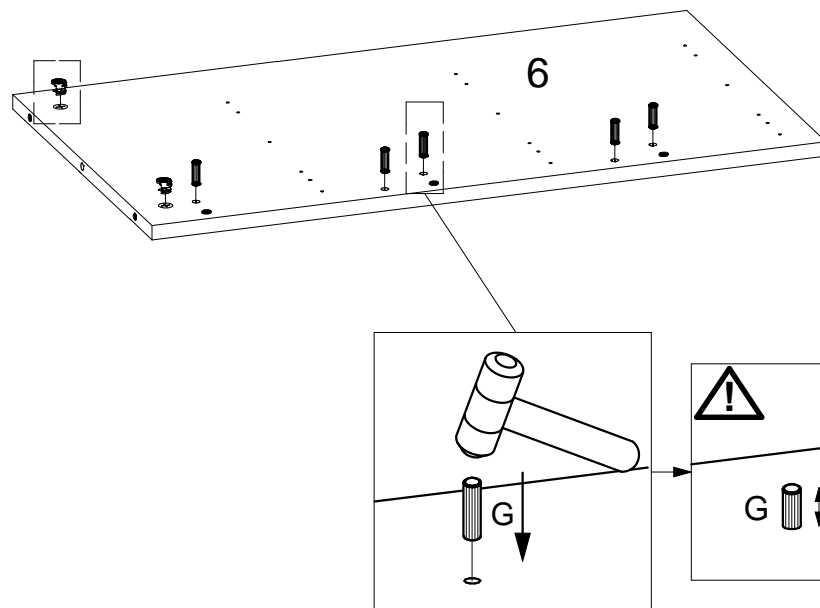
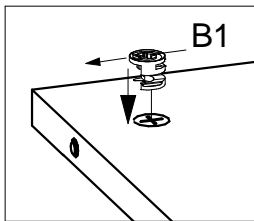
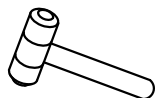
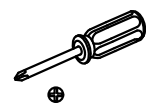

3

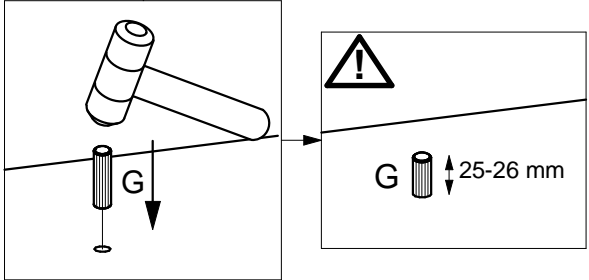
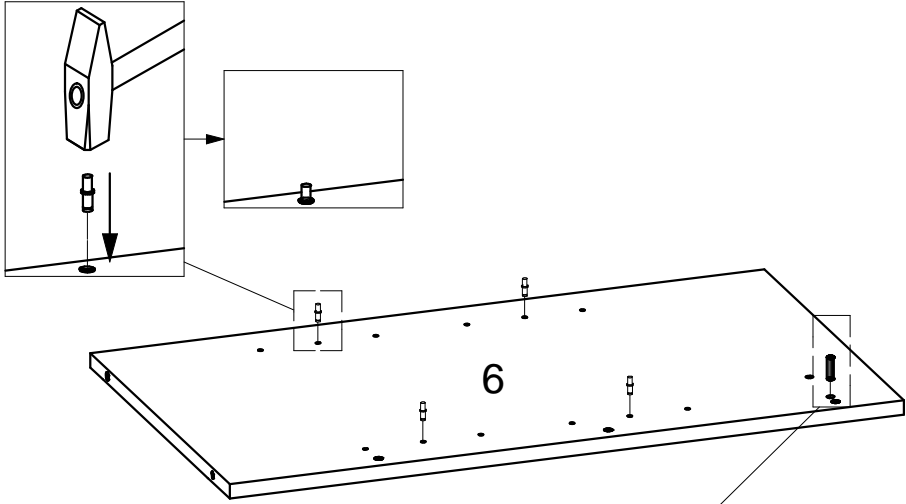

4

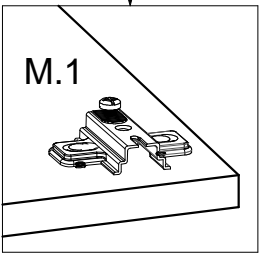
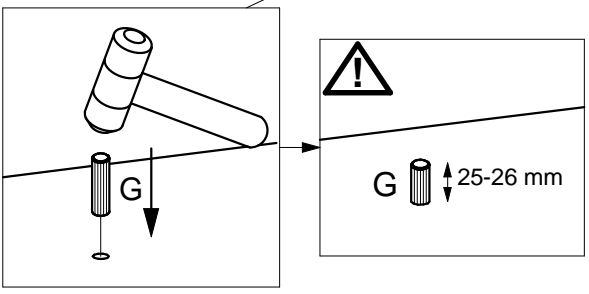
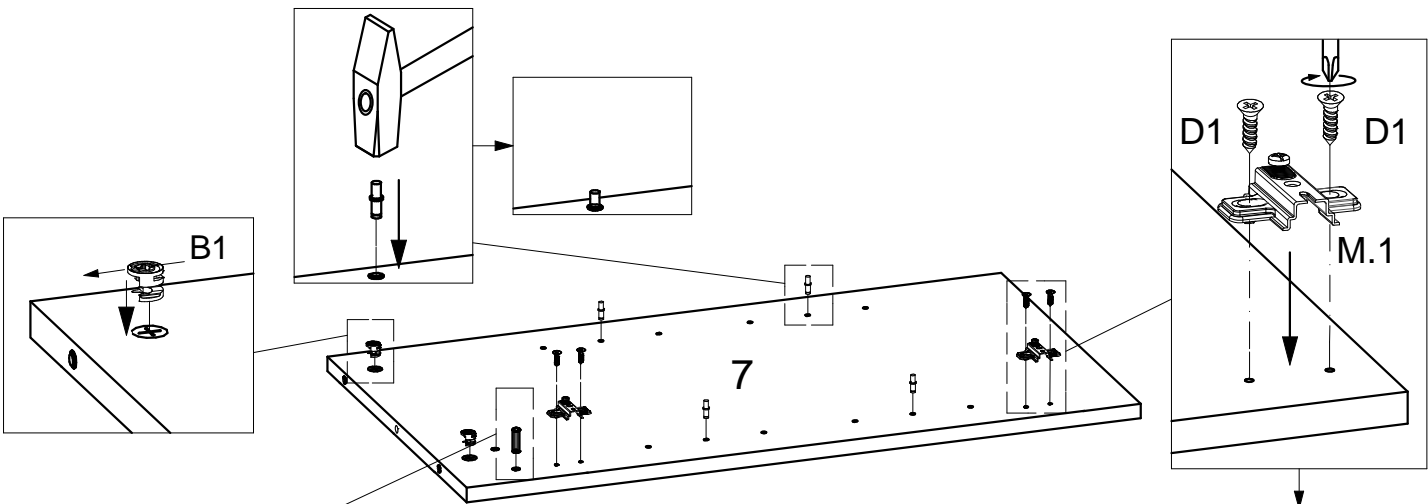
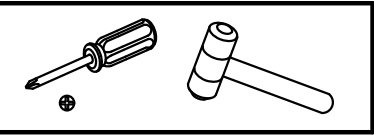
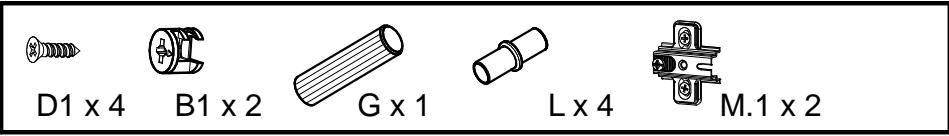

5

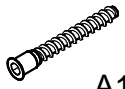

A1 x 4



A2 x 4



A3 x 1

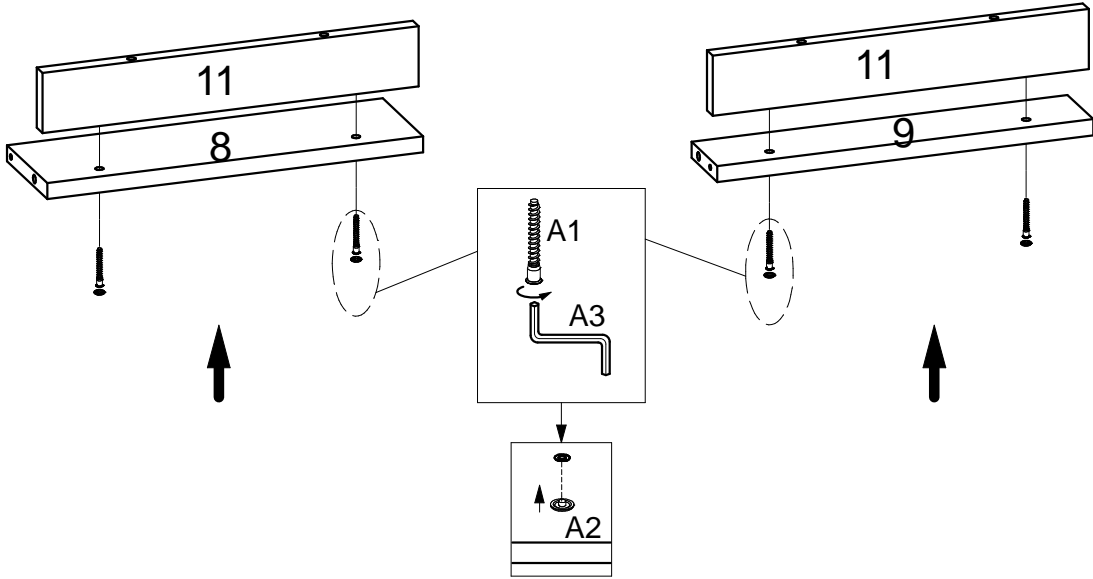

6

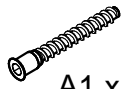

A1 x 4



A2 x 4



A3 x 1

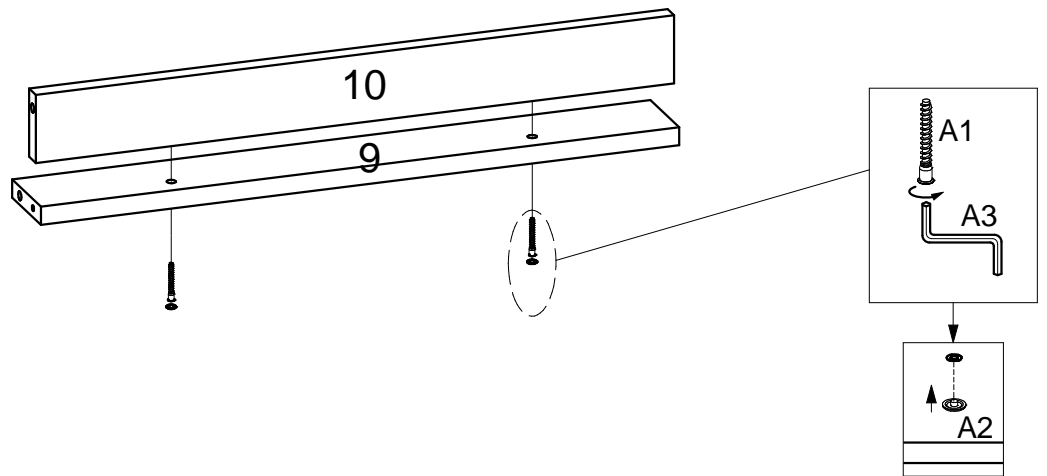

x 2

7

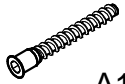

A1 x 6



A2 x 6



A3 x 1

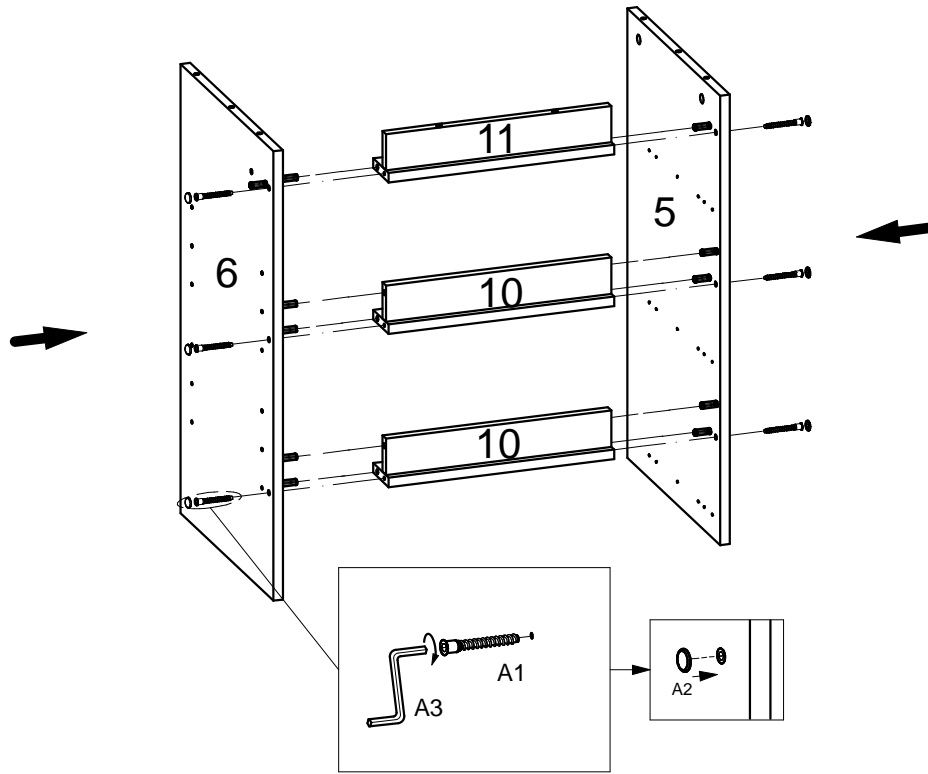
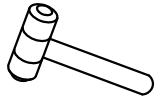

8



A1 x 2



A2 x 2



A3 x 1

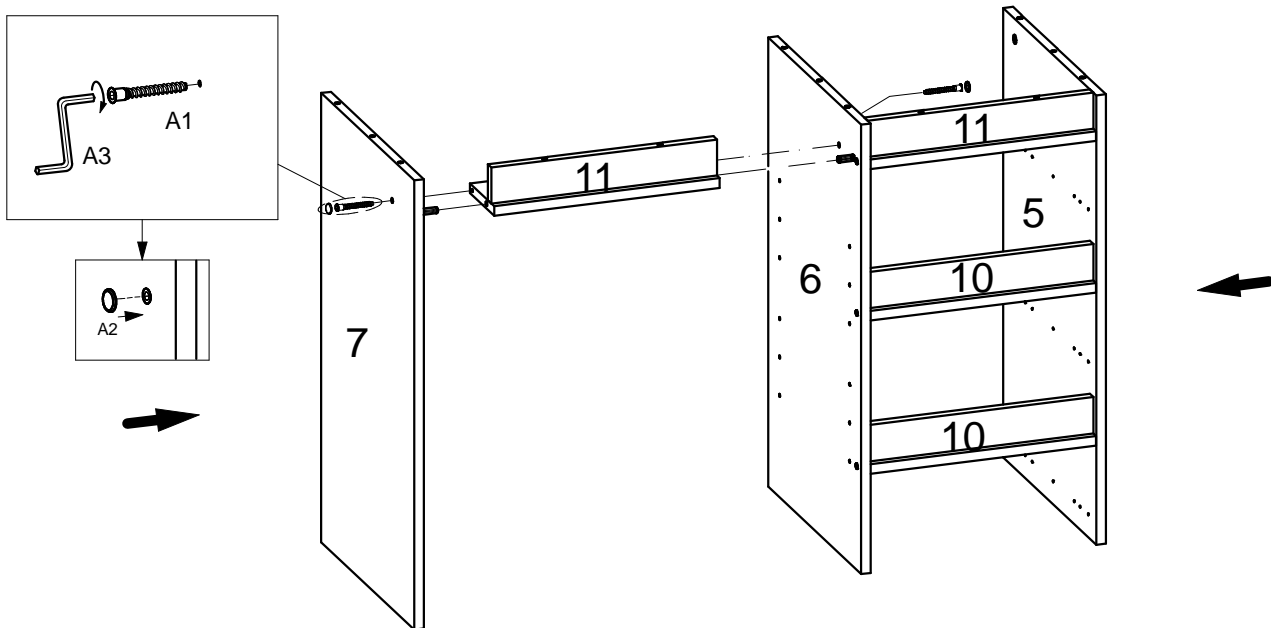
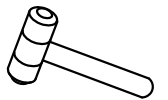

9

B2 x 6

G x 7

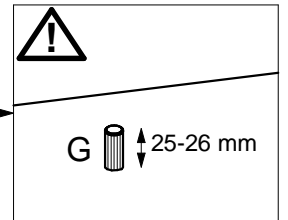
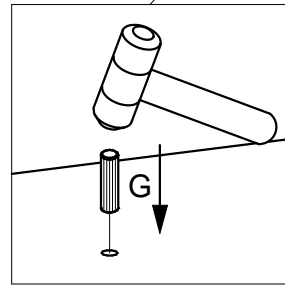
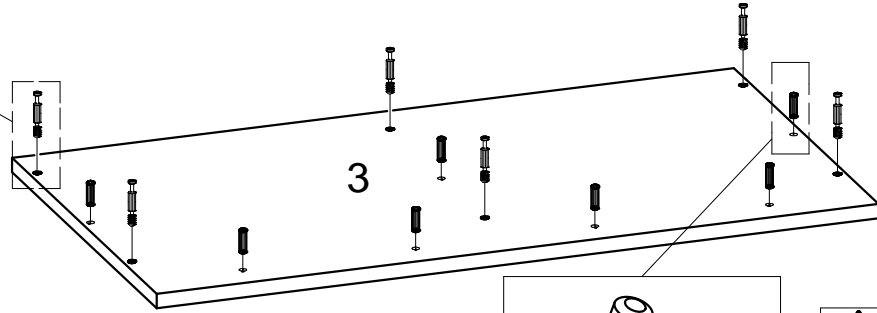
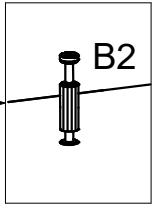
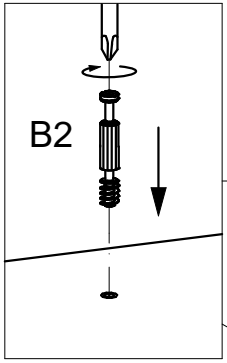
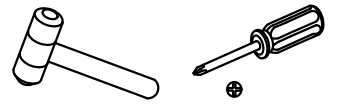

10

A1 x 6

A2 x 6

A3 x 1

B3 x 6

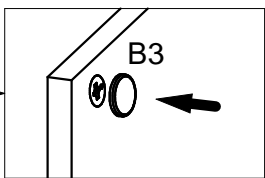
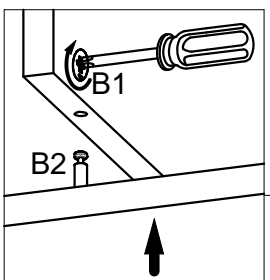
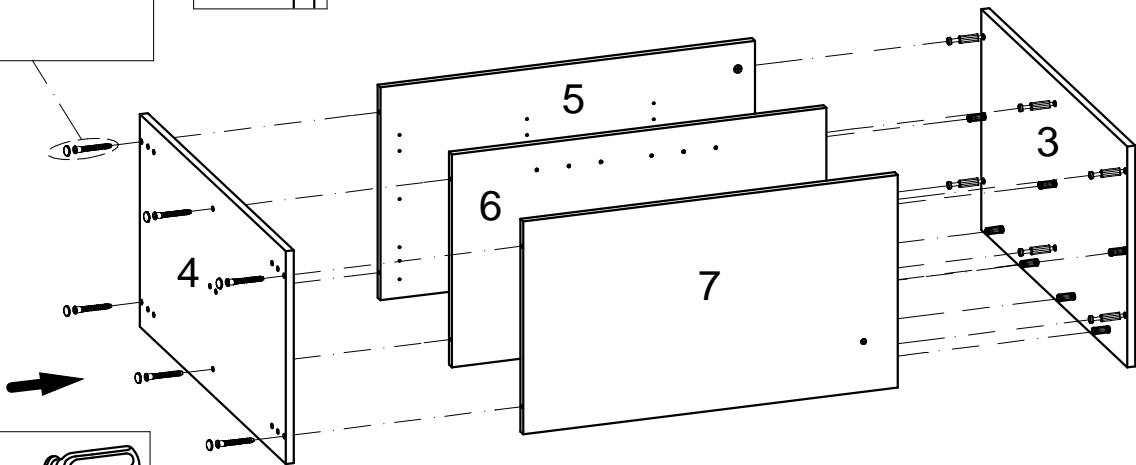
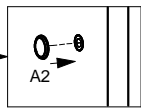
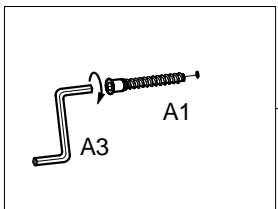
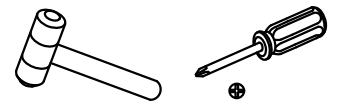

11

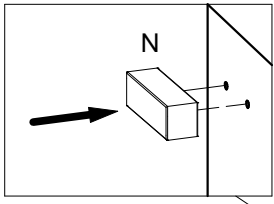
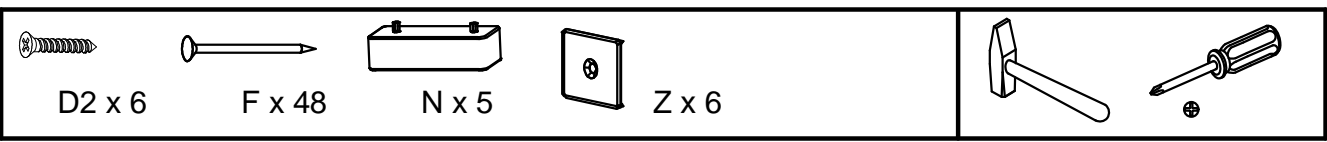

! $XX=YY=90^\circ$

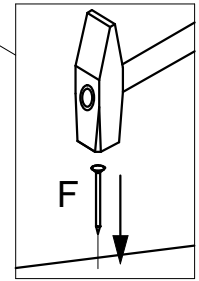
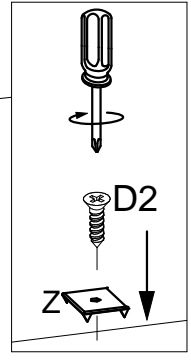
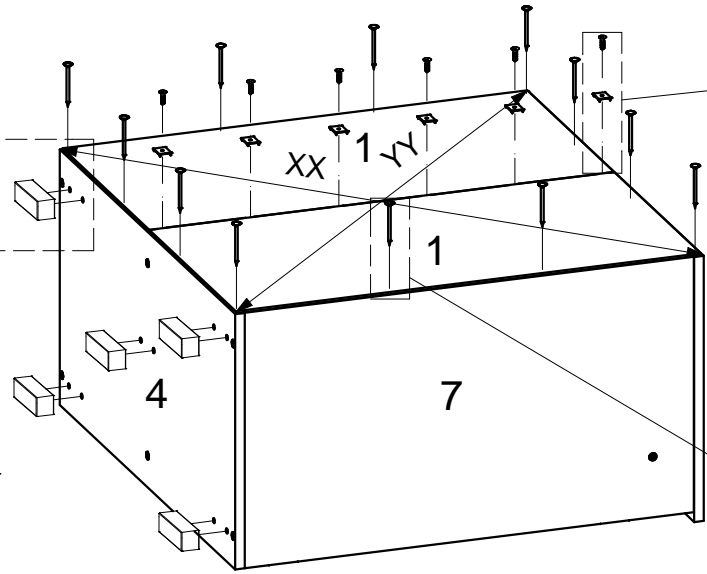

12

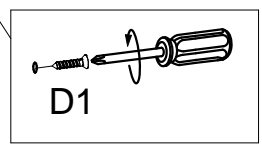
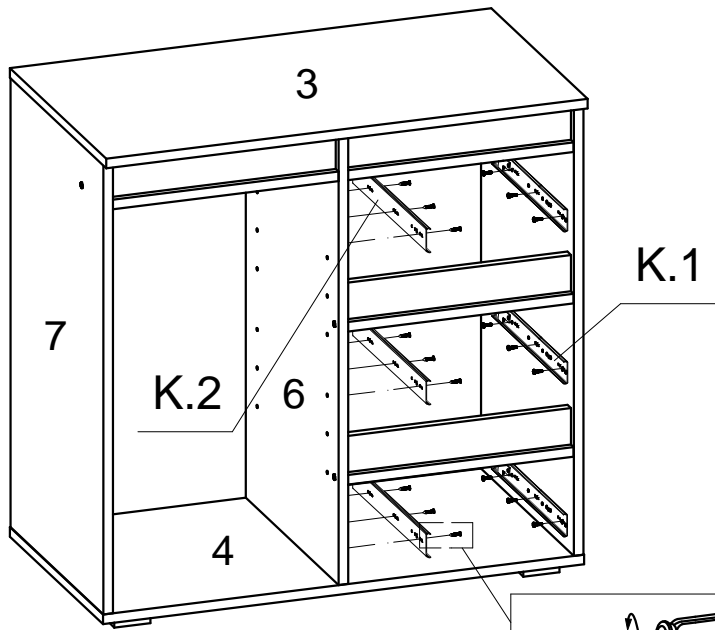

13

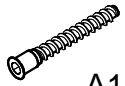

A1 x 12



A2 x 12



A3 x 1



B1 x 6

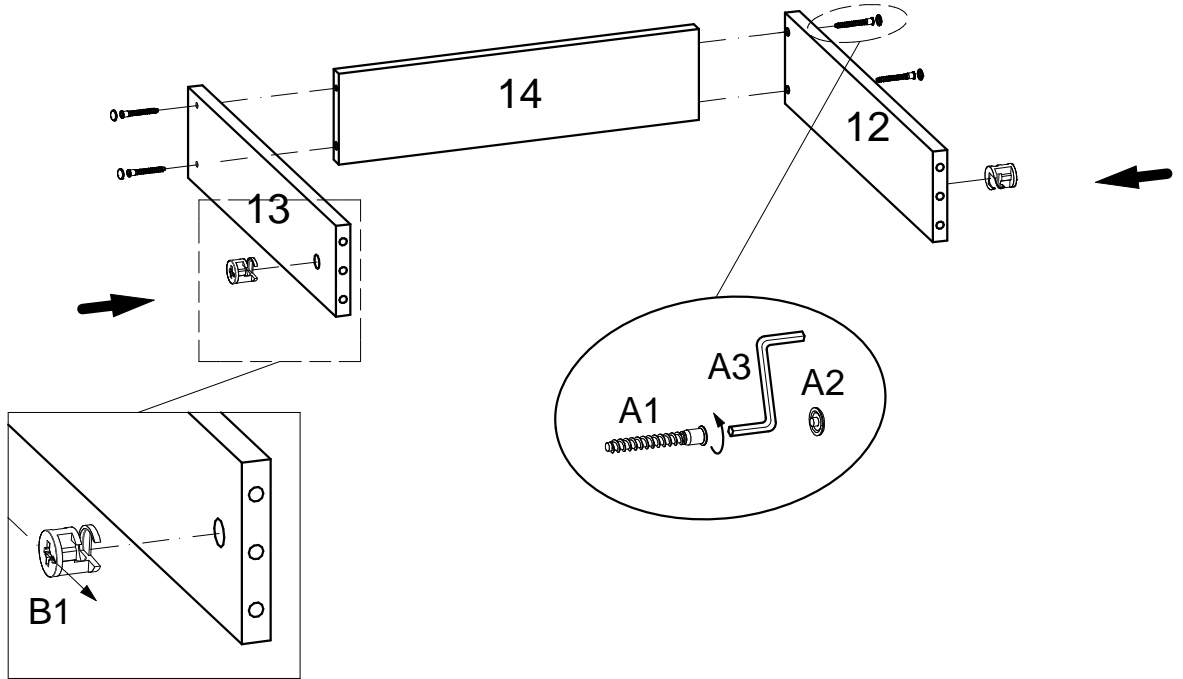

x 3

14

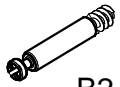

B2 x 6



B3 x 6



G x 12

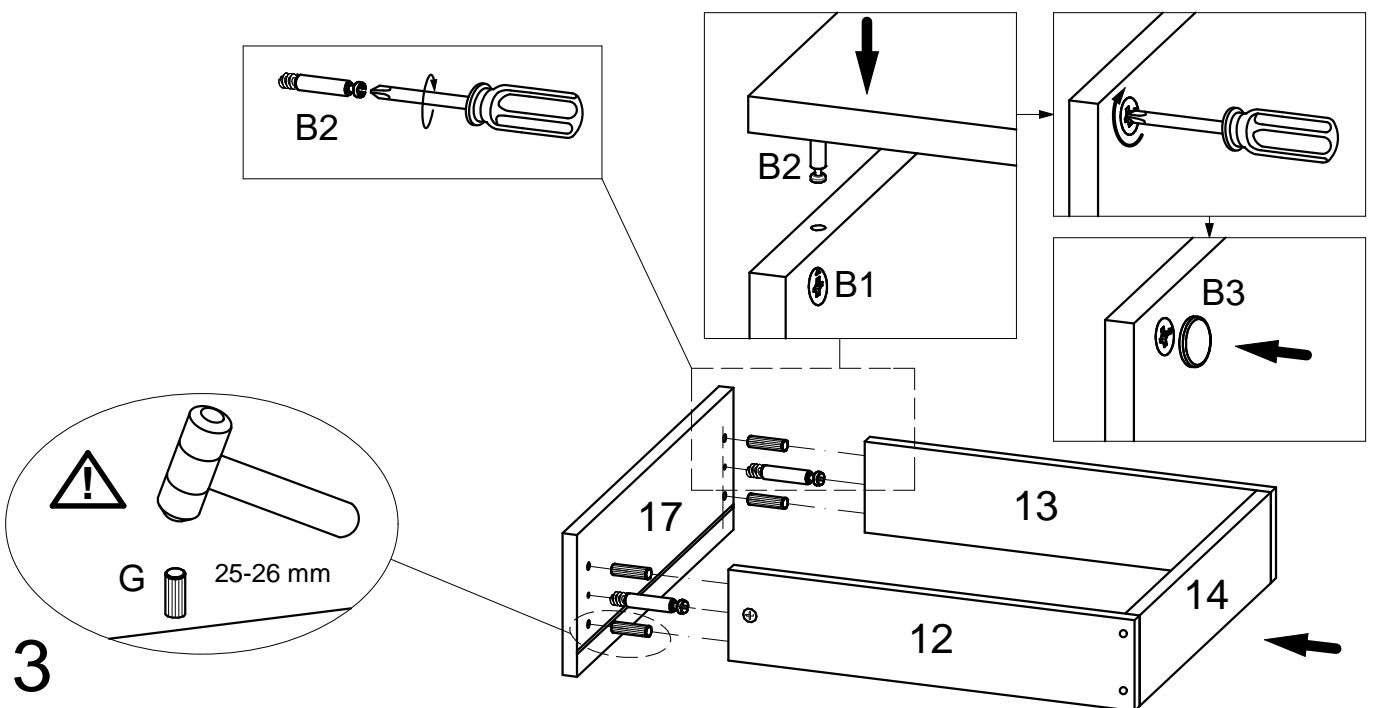
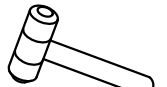
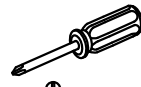

x 3

15

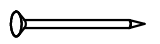

F x 66

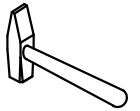

⚠ XX=YY≅90°

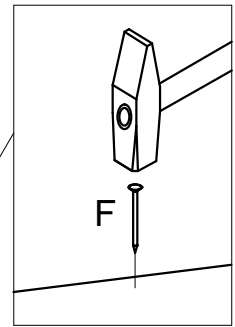
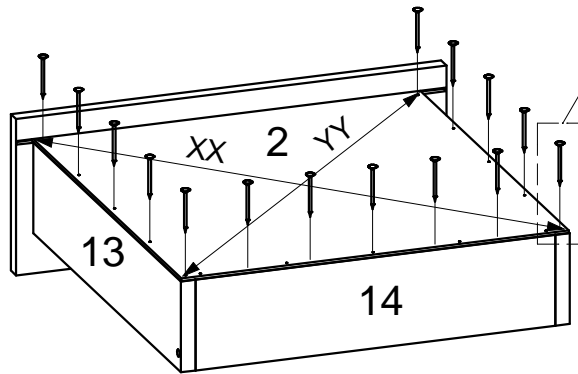

x 3

16



D1 x 18

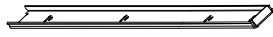

K.3 x 3



K.4 x 3

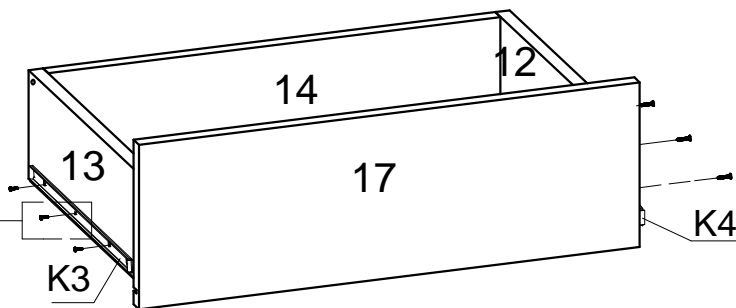
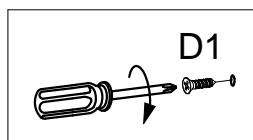
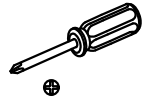

x 3

17



D1 x 4

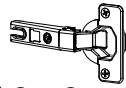

M.2 x 2

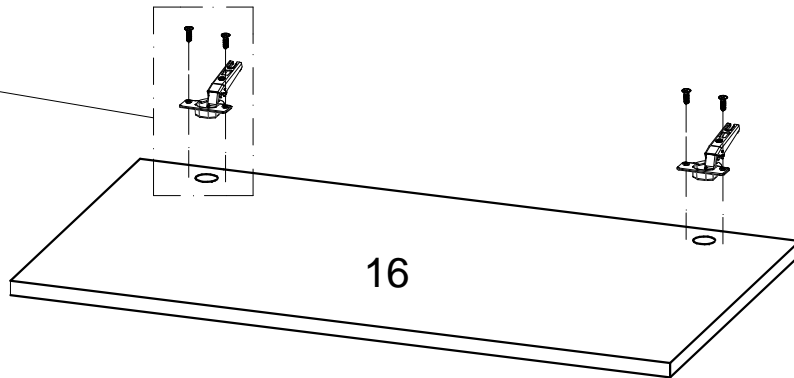
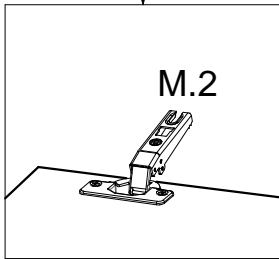
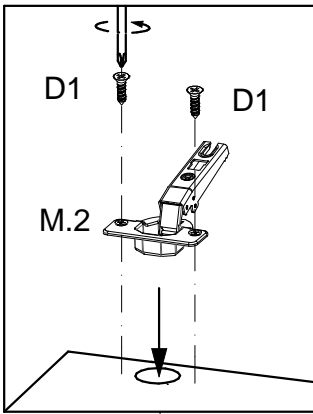
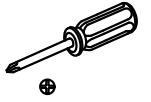

18

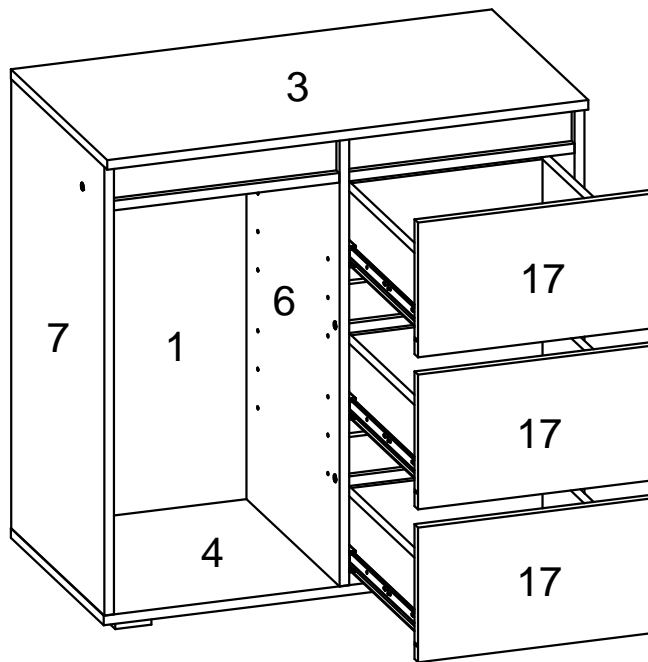

19

